



Specifications

Model Name	XJ-560	XJ-460	XJ-360
System dimensions (mm)			
Brightness*1	3000 ANSI lumens	2500 ANSI lumens	2200 ANSI lumens
Contrast ratio*2	2000:1		
Lamp	270W high-pressure mercury lamp		200W high-pressure mercury lamp
Digital keystone correction	Vertical/horizontal ±30° (Auto)		Vertical ±20° (Auto)
Focusing	Auto focus		Manual focus
Projection lens	Optical 2X zoom		
Projection screen size	15 to 300 inches		
Projection range	60" screen: 1.6m to 3.2m; 100" screen: 2.7m to 5.3m Minimum: 0.8m		
Projection method	Front/Rear/Ceiling Mount		
Projection system	DLP™ system		
Display element	0.7" DMD 786,432 pixels (1,024 x 768)		
Colour reproduction	Full colour (16.77 million colours)		
RGB input	Display resolution	True display: maximum XGA (1,024 x 768); compressed: UXGA (1,600 x 1,200)	True display: maximum XGA (1,024 x 768); compressed: SXGA (1,280 x 1,024)
	Input terminals	RGB Mini D-Sub 15 pin x 1 (YCbCr/YPbPr input, shared)	
RGB output	Output terminals	—	
Video input	Signal system	NTSC/PAL/SECAM/YCbCr/YPbPr	
	Input terminals	S-Video terminal (separate) x 1; RCA pin terminal (composite) x 1; RGB Mini D-Sub 15-pin (YCbCr/YPbPr) x 1 (RGB input, shared)	
Audio	Input	Stereo mini jack x 1	
	Output	1W monaural	
USB input	Remote mouse control		—
Power requirements	AC100–240V 50/60Hz		
Power consumption	340W	280W	260W
Dimensions (W x H x D)*3	278 x 64 x 214mm (approx.)		230 x 55 x 171mm (approx.)
Weight	2.7kg (approx.)		1.8kg (approx.)
Remote control	Wireless remote controller with laser pointer		Wireless remote controller
Security compatibility	Kensington-compatible/Power On Password/Key Lock		
Other functions	Direct Power Off, Digital Zoom, Picture in Picture, Custom Logo, Mute, Freeze, Pointer, Colour Mode, Low-noise Mode (XJ-560 only)		Digital Zoom, Mute, Freeze, Pointer, Colour Mode, Low-noise Mode
Supplied accessories	RGB cable/USB cable (XJ-560/XJ-460 only)/video cable/remote controller/dry-cell batteries (for remote controller)/carrying bag/user manual (CD-ROM)/simple user manual/warranty/AC cord		
Regulations	Satisfies the following regulations and standards: IEC60950-1; UL-listed (UL60950-1, CSA60950-1); Industry Canada ICES-003 Class B; FCC Part 15 Class B; Low Voltage Directive (EN60950-1, NEMKO-approved); EMC Directive (EN55022 Class B, EN55024, EN61000-3-2, EN61000-3-3); ACA rules (AS/NZS 3548 Class B); PSB-approved; MIC-approved; Electrical Appliance and Material Safety Law (S-JQA-approved); VCCI Class B.		

*1 ANSI lumens are units for measuring the luminosity of projected images based on the measurement method defined in IT7.228 of the American National Standards Institute. *2 In telephoto mode *3 Excluding protrusions

Projection distance

Screen size	WIDE	TELE
40-inch	1.1 m	2.1 m
60-inch	1.6 m	3.2 m
80-inch	2.2 m	4.3 m
100-inch	2.7 m	5.3 m
150-inch	4.1 m	8.0 m
200-inch	5.5 m	10.6 m
300-inch	8.3 m	16.1 m

*Projection distances are rough indications for reference during installation.

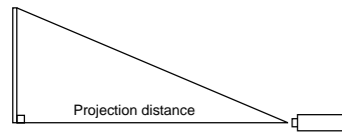

Options

Product	Model	XJ-560/460	XJ-360
Portable 60-inch screen	YN-6	Yes	Yes
Portable 80-inch screen	YN-8	Yes	Yes
Leather carrying case (Notebook PC carrier type)	YB-1	Yes	Yes
Component video cable	YK-3	Yes	Yes
Replacement lamp (for XJ-560/460)	YL-41	Yes	—
Replacement lamp (for XJ-360)	YL-31	—	Yes



For maximum convenience, use your CASSIOPEIA PRO projector in a set, with the 4-megapixel, high-resolution, multifunction camera installed.

Multifunction Camera System YC-400
4-megapixel digital camera

When case closed

Safety precautions

Please be sure to read the operator's manual carefully before using these products to ensure their safe use.

Warning: Do not use any power source voltage, connection cord or AC adapter other than those specified. To do so could result in fire or electric shock.

Caution: Do not install this product in any place where it could come into contact with water, moisture, steam, dust or oily smoke or in any high-temperature location. This may cause fire, electric shock or machine failure.

• This projector's light source is a high-voltage mercury lamp with extremely high internal pressure. Due to its characteristics, this lamp may explode with a bang or fail to ignite due to shock or overuse. The period of use before an explosion or failure may occur differs greatly, however, depending on the individual lamp and usage conditions. • Be sure to set up this equipment properly according to the instructions in the operator's manual. Failure to make connections properly or attempts to make alterations may result in accidents. CASIO cannot accept responsibility under such circumstances. • Specifications and designs are subject to change without notice. • The colour tones of the products shown may differ from the actual products due to printing. • The screen images shown are superimposed graphics.

• CASIO is a registered trademark of CASIO Computer Co., Ltd. in Japan. • CASSIOPEIA is a registered trademark of CASIO Computer Co., Ltd. • DLP, the DLP logo and the DLP medallion are trademarks of Texas Instruments. • XGA is a registered trademark of International Business Machines Corporation in the United States. • Windows is a registered trademark of Microsoft Corporation in the USA and/or other countries. • Other product names or company names in this catalogue are either trademarks or registered trademarks of their respective owners. • This catalogue is current as of December 2004.

<http://world.casio.com/>



BS0412-030001A Printed in Japan
Printed on recycled paper



The Presentation Tool That Assures Success



XJ-560 3000 ANSI lumens / XJ-460 2500 ANSI lumens

SUPER-MOBILE Model



XJ-360 2200 ANSI lumens

CASSIOPEIA® PRO

New CASIO data projectors designed to meet the demands of today's business world.

Meeting the need for quick, easy installation and further enhanced performance

Data Projector

XJ-560

3000 ANSI lumens high luminosity

Compact · True XGA support

- 3000 ANSI lumens
- Compact
- 2.7 kg
- XGA support
- ZOOM 2X
- ±30° AUTO
- ±30° AUTO
- Auto Focus
- Remote controller with laser
- Simple Key
- Sub Key
- Colour Mode
- Rear Projection
- Custom Logo
- PinP
- Mute
- Freeze
- Direct Power Off
- Low-noise Mode
- Kensington slot
- Ceiling Mount



Data Projector

XJ-460

2500 ANSI lumens high luminosity

Compact · True XGA support

- 2500 ANSI lumens
- Compact
- 2.7 kg
- XGA support
- ZOOM 2X
- ±30° AUTO
- ±30° AUTO
- Auto Focus
- Remote controller with laser
- Simple Key
- Sub Key
- Colour Mode
- Rear Projection
- Custom Logo
- PinP
- Mute
- Freeze
- Direct Power Off
- Kensington slot
- Ceiling Mount



Main XJ-560/XJ-460 Functions

Vertical/Horizontal Keystone Correction & Auto Focus Ensuring quicker installation

The XJ-560 and XJ-460 are equipped with a vertical/horizontal keystone correction function to correct projector display distortions automatically and an auto focus function to fine-tune the focus for you. These features provide one-touch correction of display distortions resulting from projector installation at angles up to $\pm 30^\circ$, vertically or horizontally, and make appropriate focusing adjustments simultaneously. This eliminates installation hassles and ensures that your meetings go smoothly, even in small rooms with limited choices of installation positions.

Auto keystone image distortion correction

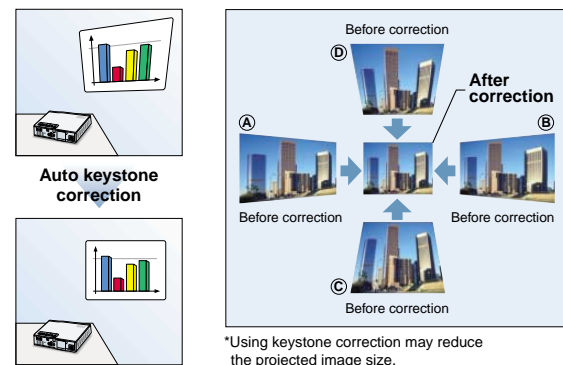
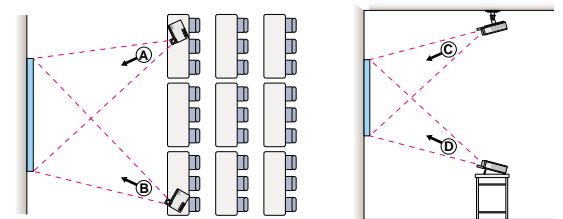

Direct Power Off Providing quicker post-use cool-down

The cooling fan continues to operate for a certain time, even after the power is turned off and the power cord unplugged — freeing you to pack up your materials and take the projector to your next presentation without delay. * Be sure not to replace the projector in the carrying bag until the main unit has cooled down fully after use.

3000 ANSI Lumens* Lamp Ensuring clear projection even in bright conditions!



The XJ-560 achieves remarkably high luminosity of 3000 ANSI lumens despite its compact size. This means everyone can see the projected images clearly without dimming the lights, even in brightly lit meeting rooms. The addition of an aspherical Acornic Reflector (ACR) maximises the lamp's capabilities, ensuring projection of even clearer, more luminous images. * 2500 ANSI lumens with XJ-460

Picture in Picture Permitting layered display of images and movies

Picture in Picture lets you display images and movies from the VIDEO or S-VIDEO input terminal as small screens over a projected background image. And the ability to reposition these small screens or adjust their size in three steps opens up new possibilities for enriched information communication.



Input VIDEO (or S-VIDEO) image

Custom Logo Projection

The custom logo projection function enables you to begin presentations by projecting your organisation's logo or mark on the opening screen. This makes a strong impact on your audience and gets your presentations off to an impressive start.

An optimal combination of outstanding luminosity and superior mobility

Data Projector

XJ-360

2200 ANSI lumens high luminosity

Ultra-Compact · True XGA support

- 2200 ANSI lumens
- Ultra-Compact
- 1.8 kg
- XGA support
- ZOOM 2X
- ±20° AUTO
- Remote controller
- Simple Key
- Colour Mode
- Rear Projection
- RGB output
- Mute
- Freeze
- Low-noise Mode
- Kensington slot
- Ceiling Mount



Main XJ-360 Functions

Compact & Lightweight, with 2200 ANSI Lumens Achieving high luminosity in a compact body

The XJ-360 with its ultra-compact A5 file size and weight of only approximately 1.8 kg achieves remarkably high 2200 ANSI lumens luminosity. Its compact body lets you transport it effortlessly, whether to a different meeting room or on a business trip. The newly developed optical system features such original new technologies as our proprietary Inverse Meniscus Condenser (IMC) lens, which serves as its core, and our new aspherical Acornic Reflector (ACR), which maximises the capabilities of the projection lamp. This remarkable system lets you project crisp, clear images — even without dimming the lights in brightly lit meeting rooms.



RGB Output Terminal Permitting image projection on a desktop PC monitor

The RGB output terminal enables you to connect the projector to a desktop PC monitor and project images on the monitor, simplifying PC operation.

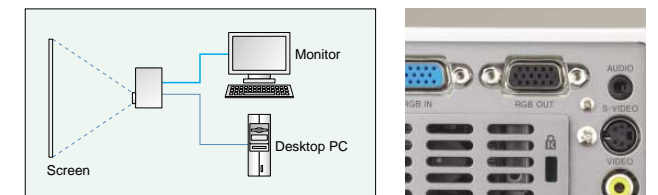

Vertical Auto Keystone Correction Counteracting screen distortions

The XJ-360 detects vertical inclinations of the main unit up to $\pm 20^\circ$ and automatically corrects distortions resulting from the installation position, thus reducing your installation challenges. You and your audience enjoy well-proportioned, easy-to-see screen images from a wider choice of projector positions.

Outstanding Shared CASSIOPEIA^{PRO} Performance Functions

A full set of remarkably advanced features affording superior image beauty, installation flexibility and operability in a compact format

High-luminosity, Compactness & Lightweight Extending your communication range

All these CASSIOPEIA^{PRO} projectors pack surprisingly advanced functions into remarkably small spaces — realising 3000 ANSI lumens/2500 ANSI lumens illumination in compact bodies or 2200 ANSI lumens in an ultra-compact body. Effortlessly transportable to any presentation venue, they project clear, vivid images with no need to dim the lights.

Wide-angle 2X Zoom Permitting a versatile installation range

Despite its compact body, the projector is equipped with a wide-angle 2X zoom lens, the maximum magnification available in a data projector.* It handles either short-range projection from as close as 0.8m when used with a 30-inch screen or long-range projection from 1.6m to 3.2m with a 60-inch screen. The ability to project images clearly on a large screen, even when installed a short distance from the screen, makes CASSIOPEIA^{PRO} ideal for use in rooms of all sizes, from small meeting rooms to large classrooms.

* As of October 2004 (according to CASIO survey information)

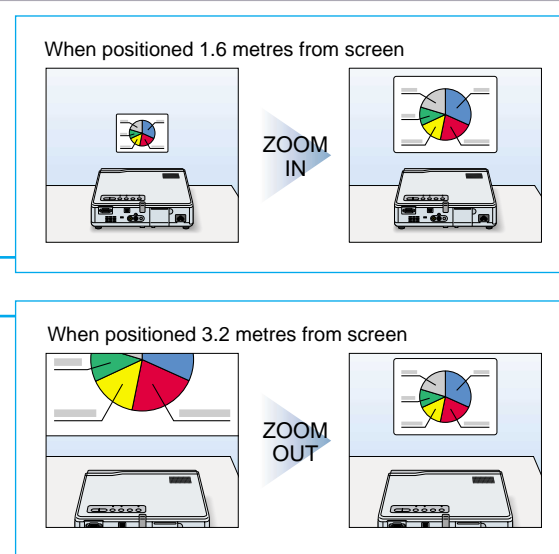
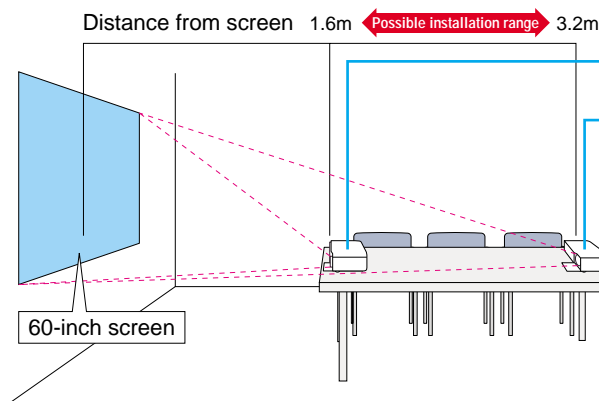

True XGA Compatibility Ensuring clear image projection

CASSIOPEIA^{PRO} projectors employ a high-definition DMD (digital micromirror device) supporting true XGA (1,024 x 768 dot) to achieve a vivid image reproduction capability. UXGA (1,600 x 1,200) compression display is also available. These specifications ensure that the images you project are always crisp and clear.

* The XJ-360 features SXGA (1,280 x 1,024) compression display.

Rear Projection Allowing projection from behind the screen

A simple setting change flips images over on the horizontal axis so you can project them accurately from behind the screen.

* Separately available screen with rear projection compatibility required.

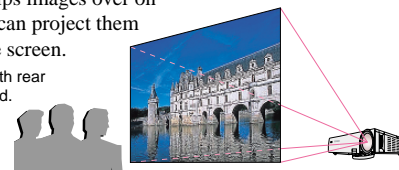

Ceiling Mount Supporting fixed-position projection

This function enables users who want to employ their CASSIOPEIA^{PRO} projector in a fixed position in a meeting room, classroom or exhibition room to hang it from the ceiling. The projector reverses the images vertically and projects them correctly, even when hung upside down from the ceiling.

* Requires separately sold hanger for installation. Inquire with your CASIO dealer for details.



Antitheft Lock Compatibility Ensuring enhanced security

An anti-theft lock hole is provided to help prevent theft before it happens.

* Use of a commercially available wire anti-theft lock possible.



Connection interface

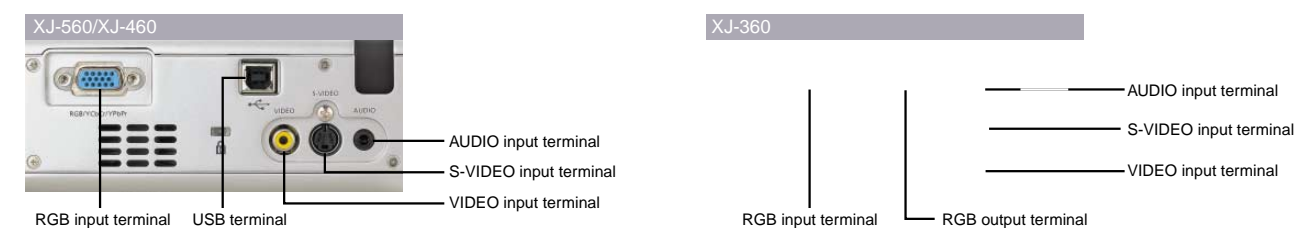

Colour Modes Adjusting images to suit varied conditions

Five built-in colour modes enable you to select the optimal luminosity depending on the image or content. This ability to adjust the colour mode setting to the situation enables you to present the images you want to project more effectively.

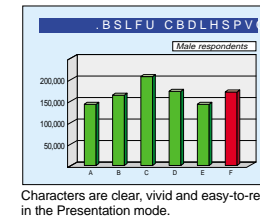

- Presentation** — A setting suited to making general presentations in bright venues
- Standard** — A setting for making effective use of colour in presentations
- Graphics** — A setting suited to presenting photos, etc., naturally
- Theatre** — A setting for showing dark areas in movies clearly
- Blackboard** — A setting offering easy-view blackboard projection

DLP^a System Supporting natural colour reproduction

The DLPTM system is an image display system employing the digital micromirror device (DMD) chip developed by Texas Instruments of the U.S. through the application of its original Digital Light ProcessingTM technology. Use of this advanced technology makes it possible to reproduce the actual colours in image data and achieves vivid, high-definition projection, even on a large screen. The system's superior reproduction capabilities also enable CASSIOPEIA^{PRO} projectors to maintain more stable image quality than projectors employing LCD systems, without colour blurring or deterioration due to the passage of time.

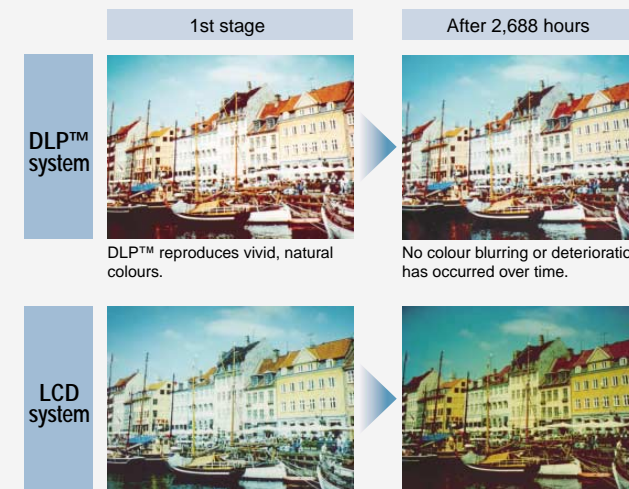

Function Marks

Basic performance

- 3000 ANSI lumens**
 - 2500 ANSI lumens**
 - 2200 ANSI lumens**
 - Ultra-Compact**
 - Compact**
 - 1.8 kg**
 - 2.7 kg**
 - XGA support**
- ANSI lumens: A lumen is a unit of measurement of luminosity. The higher the indicated numerical value, the more luminous the display. ANSI lumens are numerical values approved for the U.S. national standard.
- Size: Besides making them easy to move and remarkably mobile, these machines' compact construction also saves storage space. * XJ-560/XJ-460 dimensions: 278 x 64 x 214 mm; XJ-360 dimensions: 230 x 55 x 171 mm
- Weight: Lightweight design for easy portability. The numbers indicate the weight of the displayed model.
- True XGA: Screen display standard for 1,024 x 768 dot resolution.

Installation adjustment functions

- ZOOM 2X** Wide-angle 2X zoom: Equipped with a wide-angle 2X zoom lens offering a flexible installation range.
- ±30° AUTO** Automatic horizontal keystone correction: Automatically corrects display distortions due to projection at horizontal angles up to ±30°.
- ±30° AUTO** / **±20° AUTO** Automatic vertical keystone correction: Automatically corrects display distortions due to projection at vertical angles up to ±30° or up to ±20°.
- Auto Focus** Auto focus: Automatically corrects screen images that are out of focus due to the installation position.

Operating performance

- Remote controller** Remote controller: Equipped with a wireless remote controller permitting detailed setting operations.
- Remote controller with laser** Remote controller with laser: Equipped with a wireless remote controller featuring mouse and laser pointer functions.
- Simple Key** Simple Key: All basic operations can be performed with operation keys allocated on a panel on the surface of the main unit.
- Sub Key** Sub Key: Sub-keys installed on the main unit handle fine setting adjustment and manual operation.

Projection condition variations

- Colour Mode** Colour Mode: Equipped with five colour modes (Presentation, Standard, Graphics, Theatre and Blackboard modes) for automatic readjustment of image colour tones and contrasts, depending on the selected setting, to suit the specific projection circumstances.
- Rear Projection** Rear Projection: Projection from behind the screen is possible.
- Custom Logo** Custom Logo: Projection of a logo or other mark on the opening screen is possible.

Other functions

- RGB output** RGB output: Equipped with an RGB output terminal to enable projection of images on a desktop PC monitor.
- PinP** Picture in Picture: A function permitting overlay display of small screen images or movies on a projected background.
- Mute** Mute: Temporarily extinguishes input images and sound output from the main unit speaker.
- Freeze** Freeze: Stores the currently projected image in the main unit memory and displays it as a still image.
- Direct Power Off** Direct Power Off: The cooling fan operates for a certain time to cool the projector interior, even after the power is turned off and the power cord unplugged.
- Low-noise Mode** Low-noise Mode: Decreasing the projection luminosity permits reduction of the fan rotation speed, lowering the projector sound to below its normal quiet level.
- Kensington slot** Kensington slot: Equipped with a hole for an anti-theft lock.
- Ceiling Mount** Ceiling Mount: The projector can be hung from the ceiling for fixed-position use in meeting rooms, classrooms or exhibition rooms.